



**Spacer flange with bore
holes and port(s),
stainless steel 304L,
DN 40 CF, 2 x DN 16 CF**

PFEIFFER 

Spacer flange

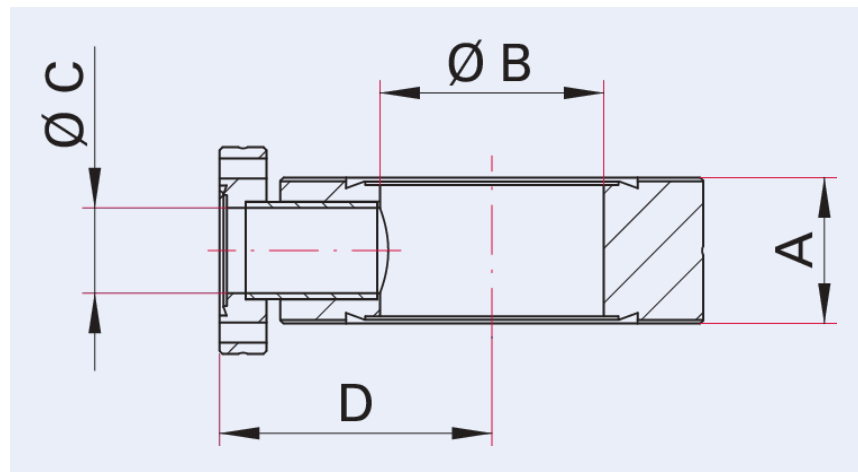

Illustration only

Spacer flange with bore holes and port(s), stainless steel 304L, DN 40 CF, 2 x DN 16 CF

- Available with up to three DN 16 CF ports with M4 metric thread
- Pipe surface: glass-bead blasted (polished version on request)
- Other flange and tube materials on request

Dimensions



A	24 mm
B	37 mm
C	14 mm
D	45 mm

Technical Data	Spacer flange with bore holes and port(s), stainless steel 304L, DN 40 CF, 2 x DN 16 CF
Number of outgoing circuits	2
Number of screws	6 Pieces
Nominal diameter reduced	DN 16 CF
Temperature range	196 – 300 °C
Tightness	1 · 10 ⁻¹¹ Pa m ³ /s 7.5 · 10 ⁻¹¹ Torr l/s 1 · 10 ⁻¹⁰ mbar l/s
Connection flange	DN 40 CF
Pressure range	1 · 10 ⁻¹² hPa – to ambient pressure
Material	Flange: stainless steel 304L; tube: stainless steel 304L or better
Temperature range max.	300 °C 572 °F 573.15 K
Temperature range min.	196 °C 320.8 °F 77.15 K

Order number	Spacer flange with bore holes and port(s), stainless steel 304L, DN 40 CF, 2 x DN 16 CF
Spacer flange with bore holes and port(s), stainless steel 304L, DN 40 CF, 2 x DN 16 CF	420FDP040-2-16



Errors and/or changes excepted. - 5/14/2025

Are you looking for an optimum vacuum solution?

Talk to us:

Pfeiffer Vacuum Components & Solutions GmbH Germany

T +49 551 99963-0

info-cs@pfeiffer-vacuum.com

Or scan the barcode, to visit our web page:



<https://webportal.pfeiffer-vacuum.com/global/en/contact>

Follow Us On Social Media

#pfeiffervacuum



www.pfeiffer-vacuum.com

PFEIFFER 