



ISO-F Port, stainless steel 304/1.4301, DN 250 ISO-F



ISO-F Port

PFEIFFER 



Illustration only

ISO-F Port, stainless steel 304/1.4301, DN 250 ISO-F

Dimensions

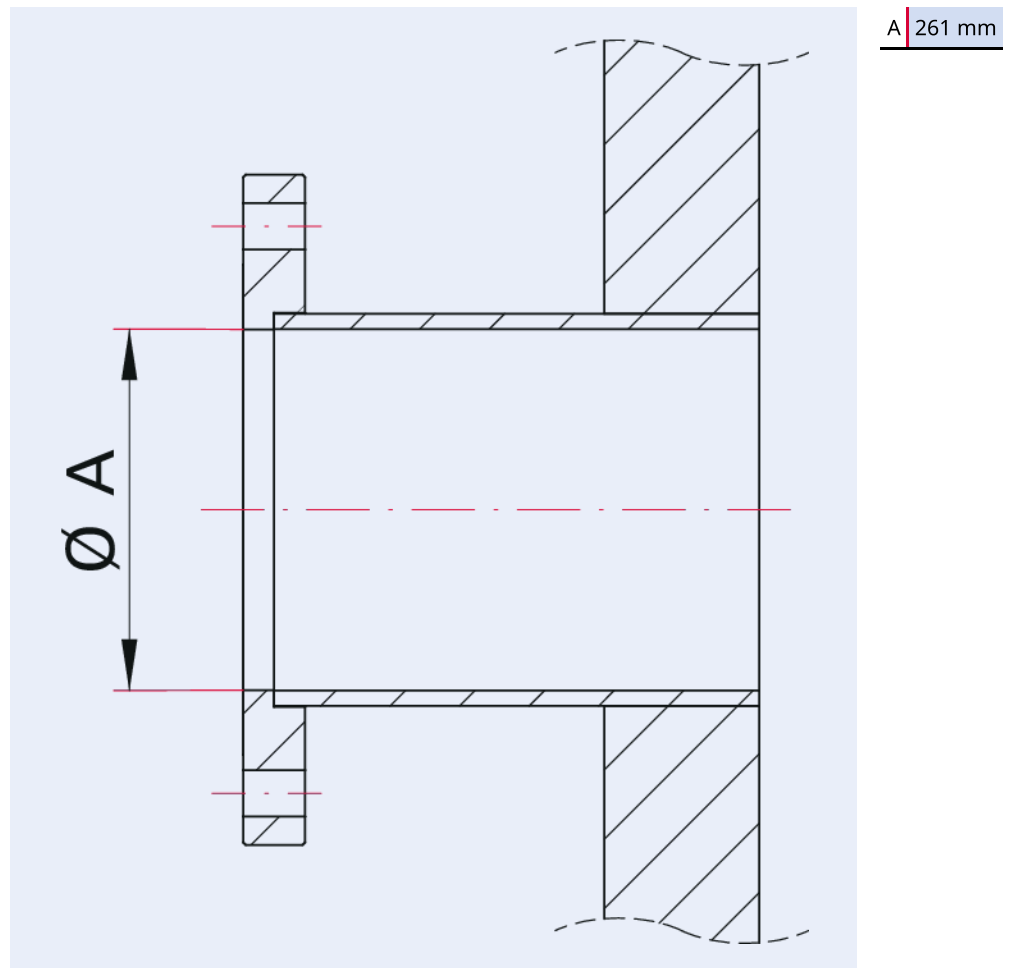

Technical Data	ISO-F Port, stainless steel 304/1.4301, DN 250 ISO-F
Materials in contact with media	Stainless steel 1.4301 (AISI 304)
Temperature range	196 – 300 °C
Connection flange	DN 250 ISO-F
Pressure range	$1 \cdot 10^{-7}$ hPa – $5 \cdot 10^2$ hPa over pressure
Temperature range max.	300 °C 572 °F 573.15 K
Temperature range min.	196 °C 320.8 °F 77.15 K

Order number	ISO-F Port, stainless steel 304/1.4301, DN 250 ISO-F
ISO-F Port, stainless steel 304/1.4301, DN 250 ISO-F	820KPF250



Errors and/or changes excepted. - 5/14/2025

Are you looking for an optimum vacuum solution?
Talk to us:
Pfeiffer Vacuum Components & Solutions GmbH Germany
T +49 551 99963-0
info-cs@pfeiffer-vacuum.com

Or scan the barcode, to visit our web page:



<https://webportal.pfeiffer-vacuum.com/global/en/contact>

Follow Us On Social Media
#pfeiffervacuum



www.pfeiffer-vacuum.com

PFEIFFER 