



Viewport, stainless steel / kodial / lead glass DN 100 CF



PFEIFFER 

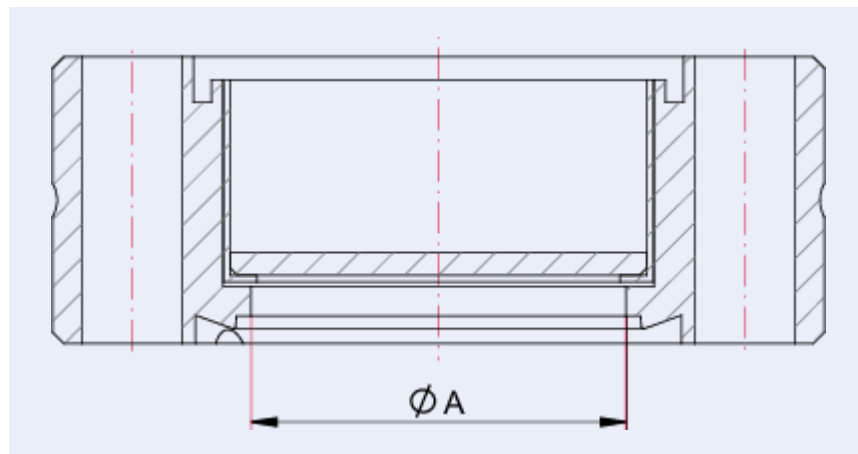

Illustration only

Viewport, stainless steel / kodial / lead glass DN 100 CF

- Please use annealed copper gaskets or elastomer seals to minimize stress inside the glass
- Always use washers for installation
- Flange sizes DN 16 to DN 250 compatible with ISO 3669:2020
- On the atmosphere side, the lead glass loosely lies on the vacuum glass, fixated with clamps
- Caution! Risk of injury by glass splinters. Do not use viewports which show apparent damage

Dimensions



A | 89 mm

Technical Data	Viewport, stainless steel / kodial / lead glass DN 100 CF
Temperature range	20 – 200 °C
Heat up and cool down rate	≤3 K/min
Connection flange	DN 100 CF
Pressure range	1 · 10 ⁻¹¹ hPa – to ambient pressure
Material	Stainless steel / Kodial / Lead Glass
Temperature range max.	200 °C 392 °F 473.15 K
Temperature range min.	20 °C 4 °F 253.15 K

Order number	Viewport, stainless steel / kodial / lead glass DN 100 CF
Viewport, stainless steel / kodial / lead glass DN 100 CF	420GSG100-PB



Errors and/or changes excepted. - 5/14/2025

Are you looking for an optimum vacuum solution?

Talk to us:

Pfeiffer Vacuum Components & Solutions GmbH Germany

T +49 551 99963-0

info-cs@pfeiffer-vacuum.com

Or scan the barcode, to visit our web page:



<https://webportal.pfeiffer-vacuum.com/global/en/contact>

Follow Us On Social Media

#pfeiffervacuum



www.pfeiffer-vacuum.com

PFEIFFER 