



Reducer flange, stainless steel 304L, DN 160-100 CF



Reducing flange

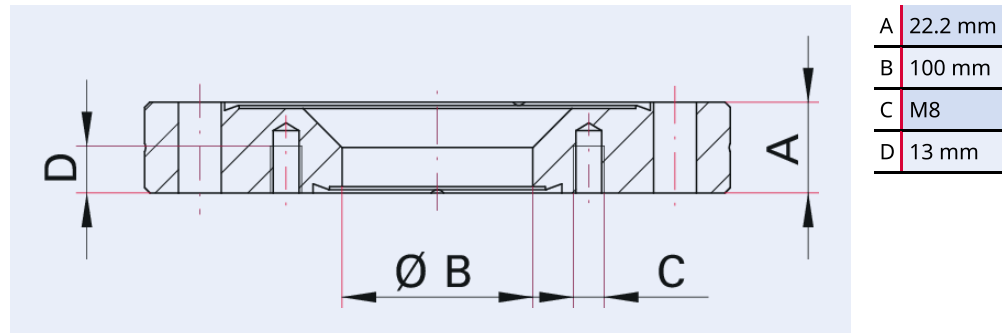

Illustration only

Reducer flange, stainless steel 304L, DN 160-100 CF

- The reduced-size flange has blind tapped holes. Make sure the screws used for installation are in the correct length

Dimensions



Technical Data	Reducer flange, stainless steel 304L, DN 160-100 CF
Materials in contact with media	Stainless steel (AISI 304L)
Number of screws	16 Pieces
Nominal diameter reduced	DN 100 CF
Temperature range	196 – 300 °C
Connection flange	DN 160 CF – DN 100 CF
Pressure range	$1 \cdot 10^{-12}$ hPa – to ambient pressure
Temperature range max.	300 °C 572 °F 573.15 K
Temperature range min.	196 °C 320.8 °F 77.15 K

Order number	Reducer flange, stainless steel 304L, DN 160-100 CF
Reducer flange, stainless steel 304L, DN 160-100 CF	420FLR160-100



Errors and/or changes excepted. - 5/14/2025

Are you looking for an optimum vacuum solution?
Talk to us:
Pfeiffer Vacuum Components & Solutions GmbH Germany
T +49 551 99963-0
info-cs@pfeiffer-vacuum.com

Or scan the barcode, to visit our web page:



<https://webportal.pfeiffer-vacuum.com/global/en/contact>

Follow Us On Social Media
#pfeiffervacuum



www.pfeiffer-vacuum.com

PFEIFFER 