



**Reducer tee, stainless
steel 304/1.4301,
DN 100/63 ISO-K**

PFEIFFER 

Reducing tee

PFEIFFER 

Reducer tee, stainless steel 304/1.4301, DN 100/63 ISO-K



Illustration only

Dimensions

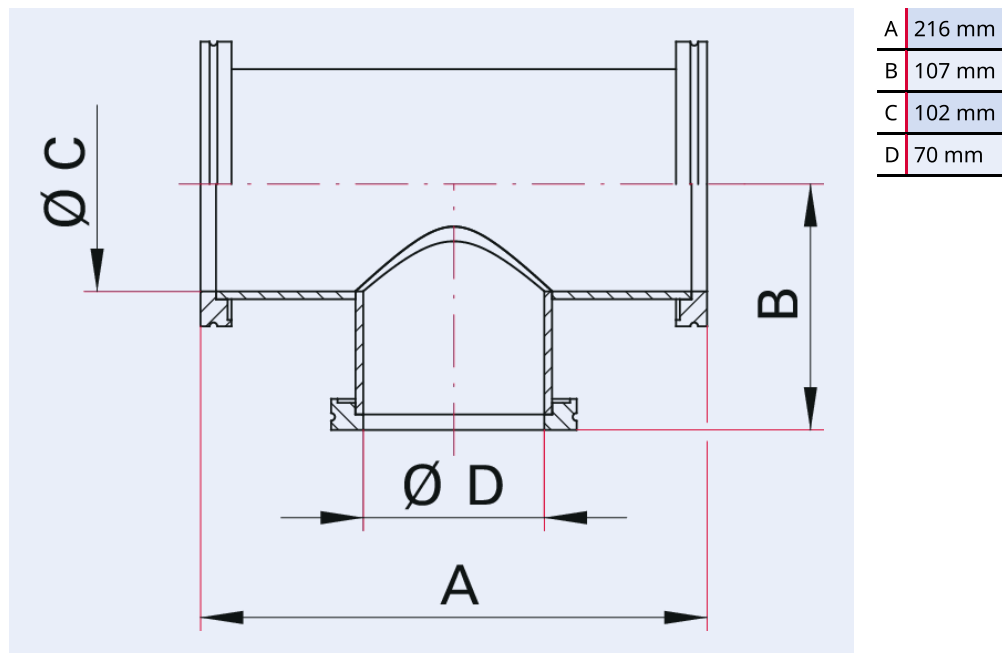

Technical Data	Reducer tee, stainless steel 304/1.4301, DN 100/63 ISO-K
Materials in contact with media	Stainless steel 1.4301 (AISI 304)
Nominal diameter reduced	DN 63 ISO-K
Temperature range	196 – 300 °C
Connection flange	DN 100 ISO-K / DN 63 ISO-K
Pressure range	1 · 10 ⁻⁸ hPa – 5 · 10 ² hPa over pressure (elastomer seal); 1 · 10 ⁻⁹ hPa – 5 · 10 ² hPa over pressure (metal seal)
Temperature range max.	300 °C 572 °F 573.15 K
Temperature range min.	196 °C 320.8 °F 77.15 K

Order number	Reducer tee, stainless steel 304/1.4301, DN 100/63 ISO-K
Reducer tee, stainless steel 304/1.4301, DN 100/63 ISO-K	320RTR100-063



Errors and/or changes excepted. - 5/14/2025

Are you looking for an optimum vacuum solution?
Talk to us:
Pfeiffer Vacuum Components & Solutions GmbH Germany
T +49 551 99963-0
info-cs@pfeiffer-vacuum.com

Or scan the barcode, to visit our web page:



<https://webportal.pfeiffer-vacuum.com/global/en/contact>

Follow Us On Social Media
#pfeiffervacuum



www.pfeiffer-vacuum.com

PFEIFFER 