



Blindflansch, Edelstahl 304L, DN 63 CF



PFEIFFER 

Blindflansch

PFEIFFER 



Blindflansch, Edelstahl 304L, DN 63 CF

Abbildung ähnlich

Maßbild

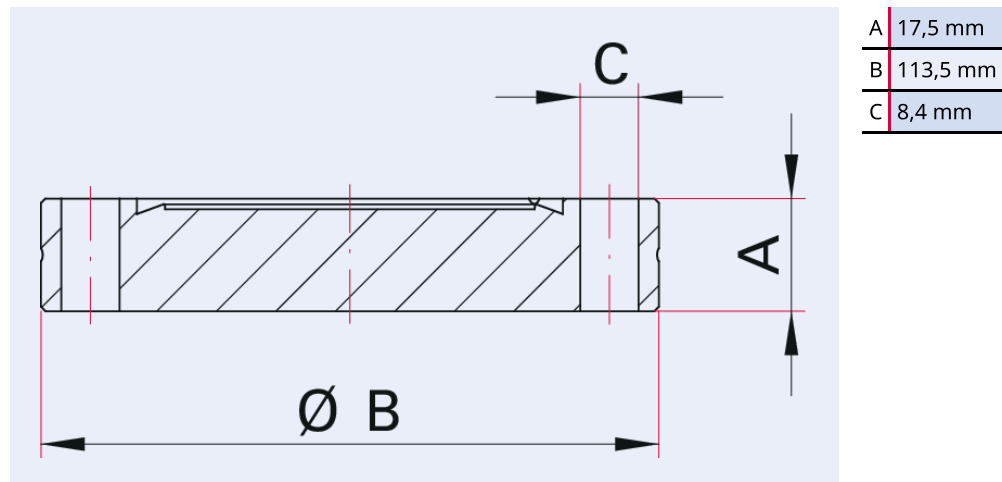

Technische Daten

Technische Daten	Blindflansch, Edelstahl 304L, DN 63 CF
Materialien mit Medienkontakt	Edelstahl (AISI 304L)
Anzahl Schrauben	8 Stück
Temperaturbereich	196 – 300 °C
Anschlussflansch	DN 63 CF
Druckbereich	$1 \cdot 10^{-12}$ hPa – Umgebungsdruck
Temperaturbereich max.	300 °C 572 °F 573,15 K
Temperaturbereich min.	196 °C 320,8 °F 77,15 K

Bestellnummer

Bestellnummer	Blindflansch, Edelstahl 304L, DN 63 CF
Blindflansch, Edelstahl 304L, DN 63 CF	420FBL063

**Sie suchen eine optimale Vakuumlösung?
Sprechen Sie uns an:**

**Pfeiffer Vacuum Components & Solutions GmbH Germany
T +49 551 99963-0
info-cs@pfeiffer-vacuum.com**

Oder scannen Sie den Barcode, um unsere Webseite zu besuchen:



https://vacuum-shop.com/shop/de_DE/



Irrtümer und/oder Änderungen vorbehalten. - 14.05.2025

**Folgen Sie uns auf Social Media
#pfeiffervacuum**



www.pfeiffer-vacuum.com

PFEIFFER 