



**Blank flange, with
metric thread, stainless
steel 304L, DN 40 CF**

PFEIFFER 

Blank flange



Illustration only

Blank flange, with metric thread, stainless steel 304L, DN 40 CF

Dimensions

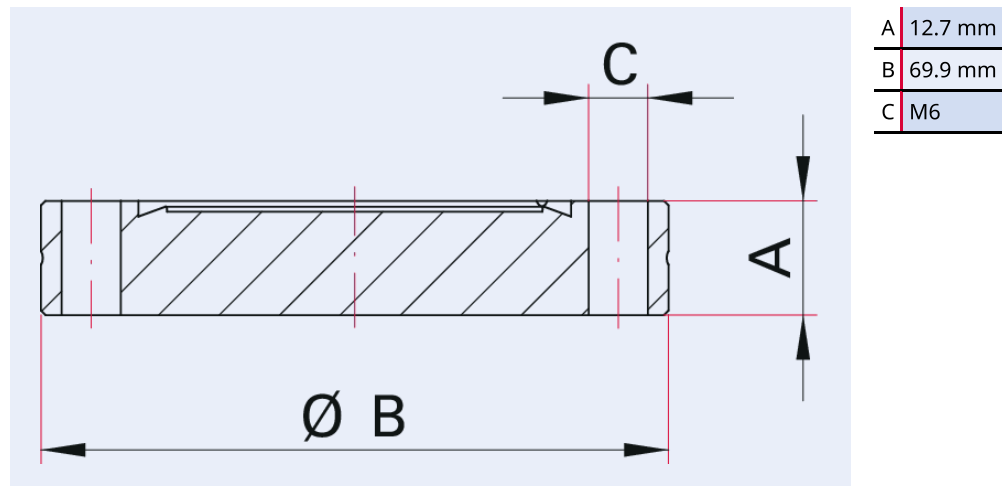

Technical Data

Blank flange, with metric thread, stainless steel 304L, DN 40 CF

Materials in contact with media	Stainless steel (AISI 304L)
Number of screws	6 Pieces
Thread	M 6
Temperature range	196 – 300 °C
Connection flange	DN 40 CF
Pressure range	$1 \cdot 10^{-12}$ hPa – to ambient pressure
Temperature range max.	300 °C 572 °F 573.15 K
Temperature range min.	196 °C 320.8 °F 77.15 K

Order number	Blank flange, with metric thread, stainless steel 304L, DN 40 CF
Blank flange, with metric thread, stainless steel 304L, DN 40 CF	420FBL040-G



Errors and/or changes excepted. - 5/14/2025

Are you looking for an optimum vacuum solution?

Talk to us:

Pfeiffer Vacuum Components & Solutions GmbH Germany

T +49 551 99963-0

info-cs@pfeiffer-vacuum.com

Or scan the barcode, to visit our web page:



<https://webportal.pfeiffer-vacuum.com/global/en/contact>

Follow Us On Social Media

#pfeiffervacuum



www.pfeiffer-vacuum.com

PFEIFFER 