

**CF to Swagelok®-
adapter, flange
stainless steel 304L,
DN 16 CF, 8 mm**



PFEIFFER 

CF to Swagelok® adapter

PFEIFFER 

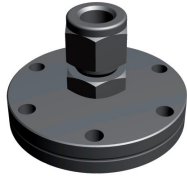
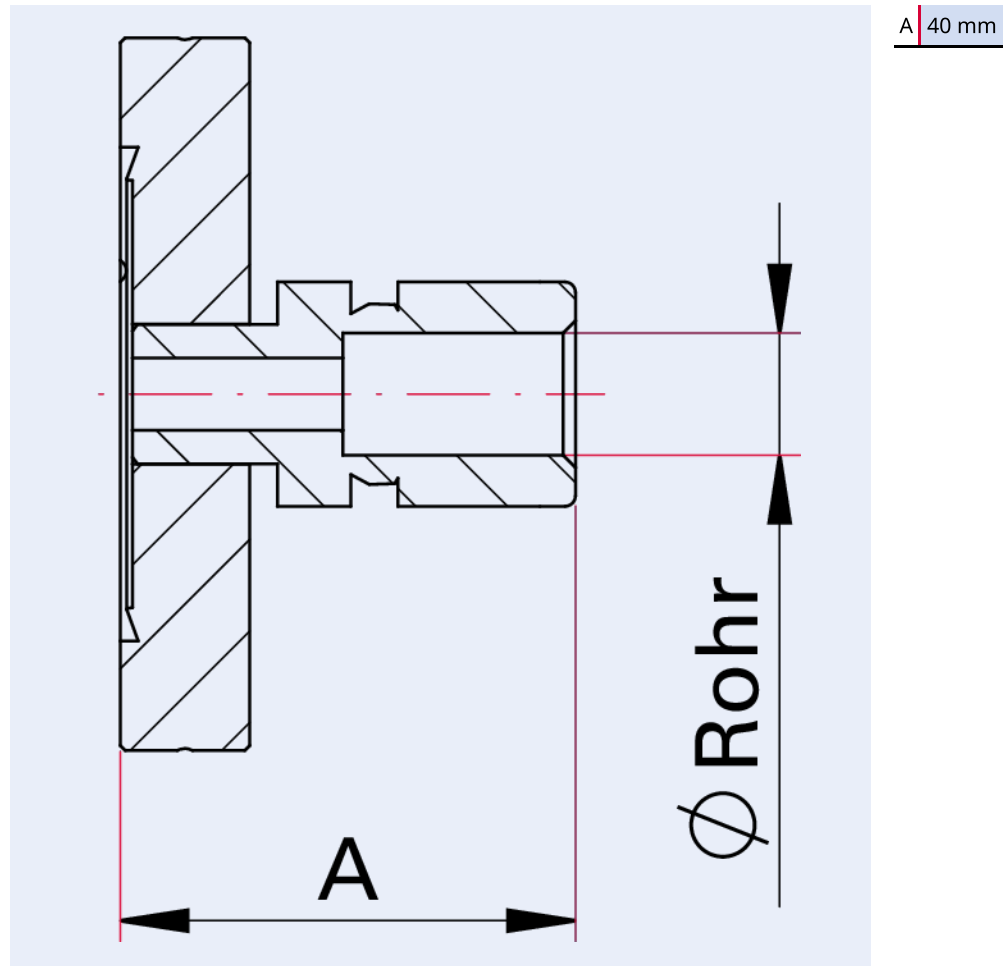

Illustration only

CF to Swagelok®-adapter, flange stainless steel 304L, DN 16 CF, 8 mm

- For metric and imperial (inch) tube diameters
- Original Swagelok® clamping collar fitting
- Other flanges sizes and pipe diameters on request

Dimensions



Technical Data	CF to Swagelok®-adapter, flange stainless steel 304L, DN 16 CF, 8 mm
Pipe external diameter	8 mm
Temperature range	196 – 300 °C
Connection flange	DN 16 CF
Pressure range	$1 \cdot 10^{-9}$ hPa – to ambient pressure
Material	Stainless steel 304L (Flange)
Temperature range max.	300 °C 572 °F 573.15 K
Temperature range min.	196 °C 320.8 °F 77.15 K

Order number	CF to Swagelok®-adapter, flange stainless steel 304L, DN 16 CF, 8 mm
CF to Swagelok®-adapter, flange stainless steel 304L, DN 16 CF, 8 mm	420ASW016-8



Errors and/or changes excepted. - 5/14/2025

Are you looking for an optimum vacuum solution?

Talk to us:

Pfeiffer Vacuum Components & Solutions GmbH Germany

T +49 551 99963-0

info-cs@pfeiffer-vacuum.com

Or scan the barcode, to visit our web page:



<https://webportal.pfeiffer-vacuum.com/global/en/contact>

Follow Us On Social Media

#pfeiffervacuum



www.pfeiffer-vacuum.com

PFEIFFER 