



**Welding flange, with
metric thread, stainless
steel 304L, DN 200 CF,
204 mm**



PFEIFFER 

Welding flange



Illustration only

Welding flange, with metric thread, stainless steel 304L, DN 200 CF, 204 mm

Dimensions

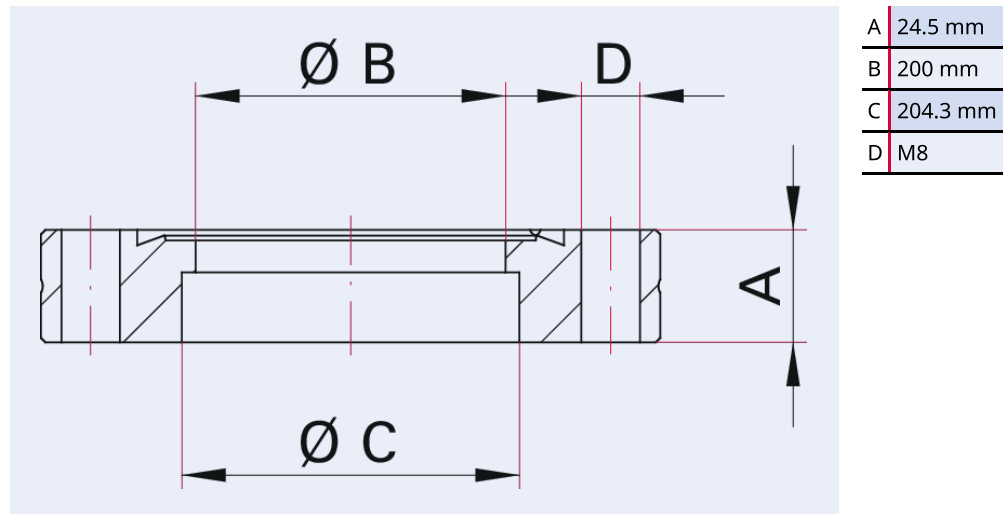

Technical Data	Welding flange, with metric thread, stainless steel 304L, DN 200 CF, 204 mm
Materials in contact with media	Stainless steel (AISI 304L)
Number of screws	24 Pieces
Pipe dimension	204 mm × 2 mm
Thread	M 8
Temperature range	196 – 300 °C
Connection flange	DN 200 CF
Pressure range	$1 \cdot 10^{-12}$ hPa – to ambient pressure
Temperature range max.	300 °C 572 °F 573.15 K
Temperature range min.	196 °C 320.8 °F 77.15 K

Order number	Welding flange, with metric thread, stainless steel 304L, DN 200 CF, 204 mm
Welding flange, with metric thread, stainless steel 304L, DN 200 CF, 204 mm	420FAN200-204-G



Errors and/or changes excepted. - 5/14/2025

Are you looking for an optimum vacuum solution?

Talk to us:

Pfeiffer Vacuum Components & Solutions GmbH Germany

T +49 551 99963-0

info-cs@pfeiffer-vacuum.com

Or scan the barcode, to visit our web page:



<https://webportal.pfeiffer-vacuum.com/global/en/contact>

Follow Us On Social Media

#pfeiffervacuum



www.pfeiffer-vacuum.com

PFEIFFER 