

**Blank flange, rotatable,
stainless steel 304L,
DN 250 CF**

PFEIFFER 

Blank flange, rotatable

PFEIFFER 



Illustration only

Blank flange, rotatable, stainless steel 304L, DN 250 CF

Dimensions

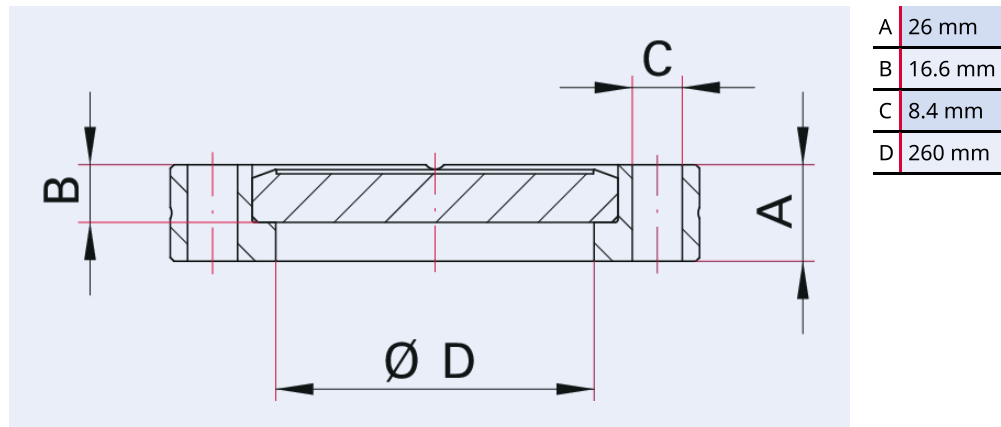

Technical Data	Blank flange, rotatable, stainless steel 304L, DN 250 CF
Materials in contact with media	Stainless steel (AISI 304L)
Number of screws	32 Pieces
Temperature range	196 – 300 °C
Connection flange	DN 250 CF
Pressure range	$1 \cdot 10^{-12}$ hPa – to ambient pressure
Temperature range max.	300 °C 572 °F 573.15 K
Temperature range min.	196 °C 320.8 °F 77.15 K

Order number	Blank flange, rotatable, stainless steel 304L, DN 250 CF
Blank flange, rotatable, stainless steel 304L, DN 250 CF	420FBD250



Errors and/or changes excepted. - 5/14/2025

Are you looking for an optimum vacuum solution?

Talk to us:

Pfeiffer Vacuum Components & Solutions GmbH Germany

T +49 551 99963-0

info-cs@pfeiffer-vacuum.com

Or scan the barcode, to visit our web page:



<https://webportal.pfeiffer-vacuum.com/global/en/contact>

Follow Us On Social Media

#pfeiffervacuum



www.pfeiffer-vacuum.com

PFEIFFER 