

**Reduzierstück, gerade,
Aluminium 3.2315/EN
AW-6082, DN 50-25 ISO-
KF, Länge 40 mm**

PFEIFFER 

Reduzierstück, gerade

PFEIFFER 



Abbildung ähnlich

Reduzierstück, gerade, Aluminium 3.2315/EN AW-6082, DN 50-25 ISO-KF, Länge 40 mm

- In Edelstahl oder Aluminium lieferbar

Maßbild

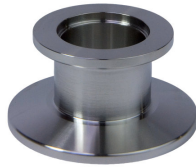
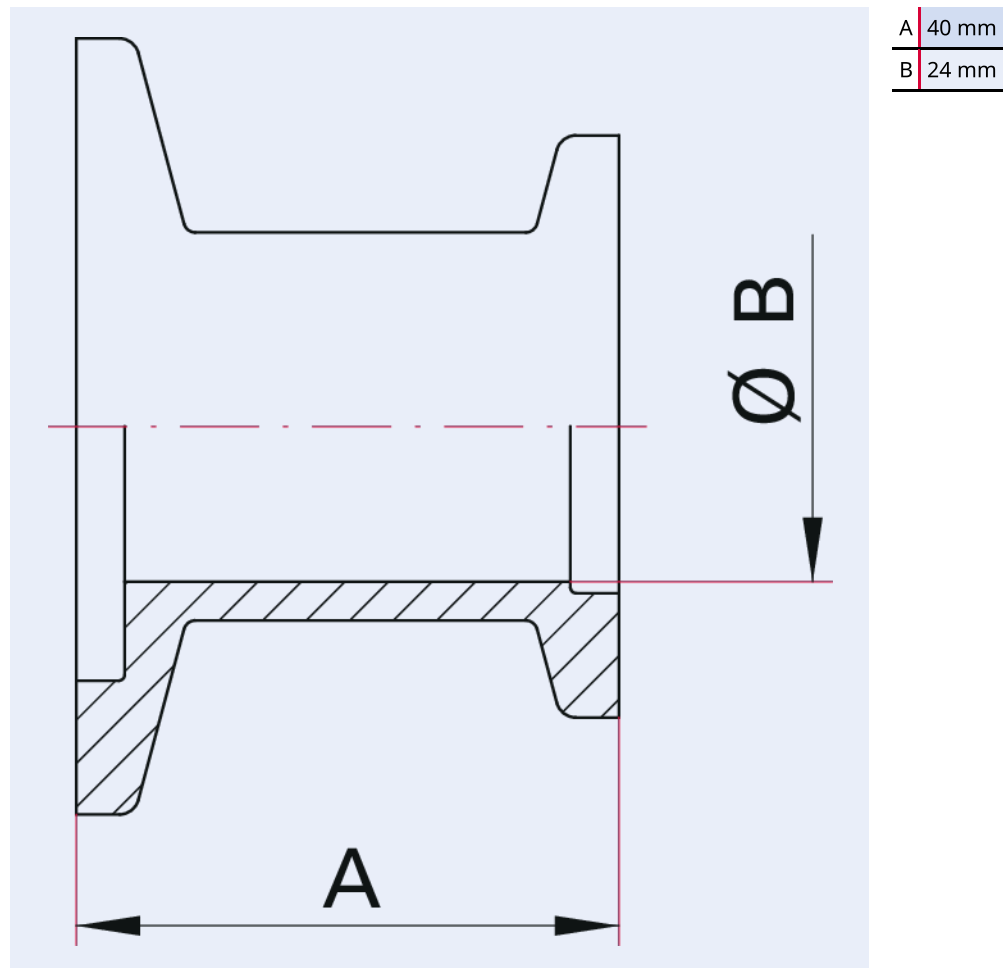

Technische Daten	Reduzierstück, gerade, Aluminium 3.2315/EN AW-6082, DN 50-25 ISO-KF, Länge 40 mm
Materialien mit Medienkontakt	Aluminium 3.2315/EN AW-6082
Nennweite reduziert	DN 25 ISO-KF
Temperaturbereich	196 – 150 °C
Anschlussflansch	DN 50 ISO-KF – DN 25 ISO-KF
Druckbereich	$1 \cdot 10^{-8}$ hPa – $5 \cdot 10^2$ hPa Überdruck
Temperaturbereich max.	150 °C 302 °F 423,15 K
Temperaturbereich min.	196 °C 320,8 °F 77,15 K

Bestellnummer	Reduzierstück, gerade, Aluminium 3.2315/EN AW-6082, DN 50-25 ISO-KF, Länge 40 mm
Reduzierstück, gerade, Aluminium 3.2315/EN AW-6082, DN 50-25 ISO-KF, Länge 40 mm	110RRG050-025-40

**Sie suchen eine optimale Vakuumlösung?
Sprechen Sie uns an:**

**Pfeiffer Vacuum Components & Solutions GmbH Germany
T +49 551 99963-0
info-cs@pfeiffer-vacuum.com**

Oder scannen Sie den Barcode, um unsere Webseite zu besuchen:



https://vacuum-shop.com/shop/de_DE/



Irrtümer und/oder Änderungen vorbehalten. - 14.05.2025

**Folgen Sie uns auf Social Media
#pfeiffervacuum**



www.pfeiffer-vacuum.com

PFEIFFER 