



**Reduzier-T-Stück,
Edelstahl 1.4301/304,
DN 50-40 ISO-KF**



PFEIFFER 

Reduzier-T-Stück

PFEIFFER 



Abbildung ähnlich

Reduzier-T-Stück, Edelstahl 1.4301/304, DN 50-40 ISO-KF

Maßbild

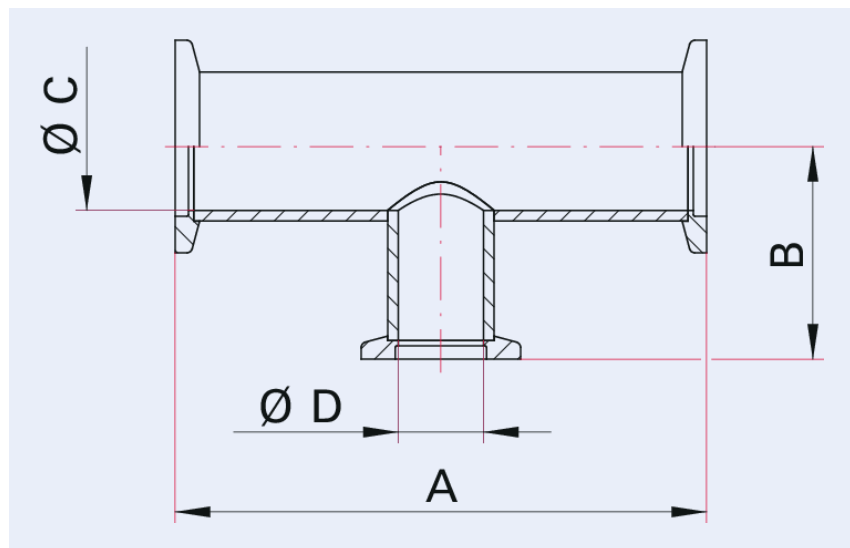

A	140 mm
B	65 mm
C	50 mm
D	40 mm

Technische Daten	Reduzier-T-Stück, Edelstahl 1.4301/304, DN 50-40 ISO-KF
Materialien mit Medienkontakt	Edelstahl 1.4301 (AISI 304)
Nennweite reduziert	DN 40 ISO-KF
Temperaturbereich	196 – 300 °C
Anschlussflansch	DN 50 ISO-KF – DN 40 ISO-KF
Druckbereich	1 · 10 ⁻⁸ hPa – 5 · 10 ² hPa Überdruck (Elastomerdichtung); 1 · 10 ⁻⁹ hPa – 5 · 10 ² hPa Überdruck (Metalldichtung)
Temperaturbereich max.	300 °C 572 °F 573,15 K
Temperaturbereich min.	196 °C 320,8 °F 77,15 K

Bestellnummer	Reduzier-T-Stück, Edelstahl 1.4301/304, DN 50-40 ISO-KF
Reduzier-T-Stück, Edelstahl 1.4301/304, DN 50-40 ISO-KF	120RTR050-040

**Sie suchen eine optimale Vakuumlösung?
Sprechen Sie uns an:**

**Pfeiffer Vacuum Components & Solutions GmbH Germany
T +49 551 99963-0
info-cs@pfeiffer-vacuum.com**

Oder scannen Sie den Barcode, um unsere Webseite zu besuchen:



https://vacuum-shop.com/shop/de_DE/



Irrtümer und/oder Änderungen vorbehalten. - 14.05.2025

**Folgen Sie uns auf Social Media
#pfeiffervacuum**



www.pfeiffer-vacuum.com

PFEIFFER 