



**Reducer tee, stainless
steel 304/1.4301, DN 50-
40 ISO-KF**

PFEIFFER 

Reducing tee

PFEIFFER 



Illustration only

Reducer tee, stainless steel 304/1.4301, DN 50-40 ISO-KF

Dimensions

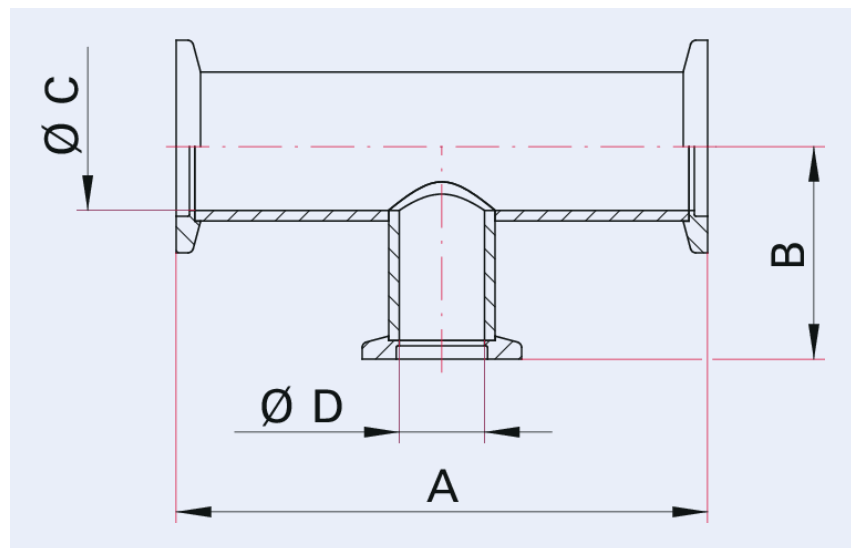

A	140 mm
B	65 mm
C	50 mm
D	40 mm

Technical Data	Reducer tee, stainless steel 304/1.4301, DN 50-40 ISO-KF
Materials in contact with media	Stainless steel 1.4301 (AISI 304)
Nominal diameter reduced	DN 40 ISO-KF
Temperature range	196 – 300 °C
Connection flange	DN 50 ISO-KF – DN 40 ISO-KF
Pressure range	1 · 10 ⁻⁸ hPa – 5 · 10 ² hPa over pressure (elastomer seal); 1 · 10 ⁻⁹ hPa – 5 · 10 ² hPa over pressure (metal seal)
Temperature range max.	300 °C 572 °F 573.15 K
Temperature range min.	196 °C 320.8 °F 77.15 K

Order number	Reducer tee, stainless steel 304/1.4301, DN 50-40 ISO-KF
Reducer tee, stainless steel 304/1.4301, DN 50-40 ISO-KF	120RTR050-040



Errors and/or changes excepted. - 5/14/2025

Are you looking for an optimum vacuum solution?

Talk to us:

Pfeiffer Vacuum Components & Solutions GmbH Germany

T +49 551 99963-0

info-cs@pfeiffer-vacuum.com

Or scan the barcode, to visit our web page:



<https://webportal.pfeiffer-vacuum.com/global/en/contact>

Follow Us On Social Media

#pfeiffervacuum



www.pfeiffer-vacuum.com

PFEIFFER 