



**Corrugated hose,
flexible, stainless steel,
DN 63 ISO-K, length
1500 mm**



PFEIFFER 

Corrugated hose

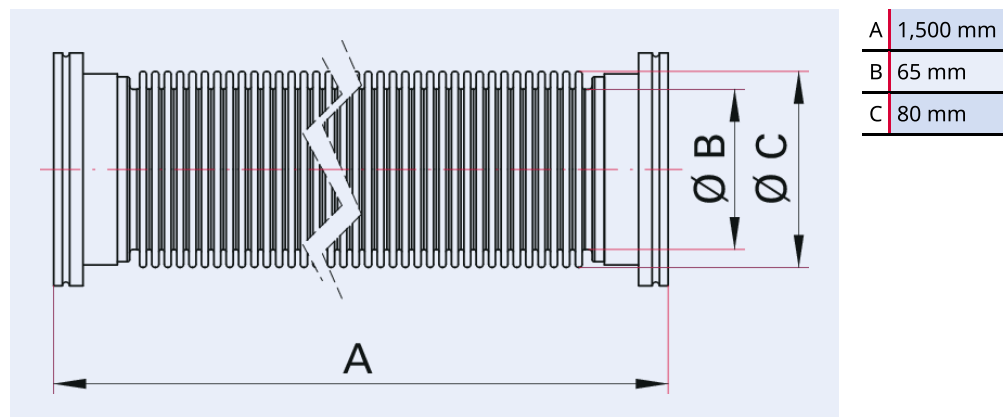

Illustration only

Corrugated hose, flexible, stainless steel, DN 63 ISO-K, length 1500 mm

- Flange connection length 30 mm
- Custom lengths on request

Dimensions



Technical Data	Corrugated hose, flexible, stainless steel, DN 63 ISO-K, length 1500 mm
Temperature range	196 – 300 °C
Overpressure max.	500 hPa 375 Torr 500 mbar
Bending radius, frequent movement	330 mm 12.99 inch
Bending radius, one-time movement	90 mm 3.54 inch
Pressure min.	$1 \cdot 10^{-8}$ hPa $7.5 \cdot 10^{-9}$ Torr $1 \cdot 10^{-8}$ mbar
Connection flange	DN 63 ISO-K
Material	Stainless steel: Flange 1.4301/304; Bellows 316L
Temperature range max.	300 °C 572 °F 573.15 K
Temperature range min.	196 °C 320.8 °F 77.15 K

Order number	Corrugated hose, flexible, stainless steel, DN 63 ISO-K, length 1500 mm
Corrugated hose, flexible, stainless steel, DN 63 ISO-K, length 1500 mm	320SWN063-1500



Errors and/or changes excepted. - 5/14/2025

Are you looking for an optimum vacuum solution?

Talk to us:

Pfeiffer Vacuum Components & Solutions GmbH Germany

T +49 551 99963-0

info-cs@pfeiffer-vacuum.com

Or scan the barcode, to visit our web page:



<https://webportal.pfeiffer-vacuum.com/global/en/contact>

Follow Us On Social Media

#pfeiffervacuum



www.pfeiffer-vacuum.com

PFEIFFER 