



**Elbow, 45°, stainless
steel 316L/1.4404,
DN 25 ISO-KF**



PFEIFFER 

Elbow, 45°

PFEIFFER 

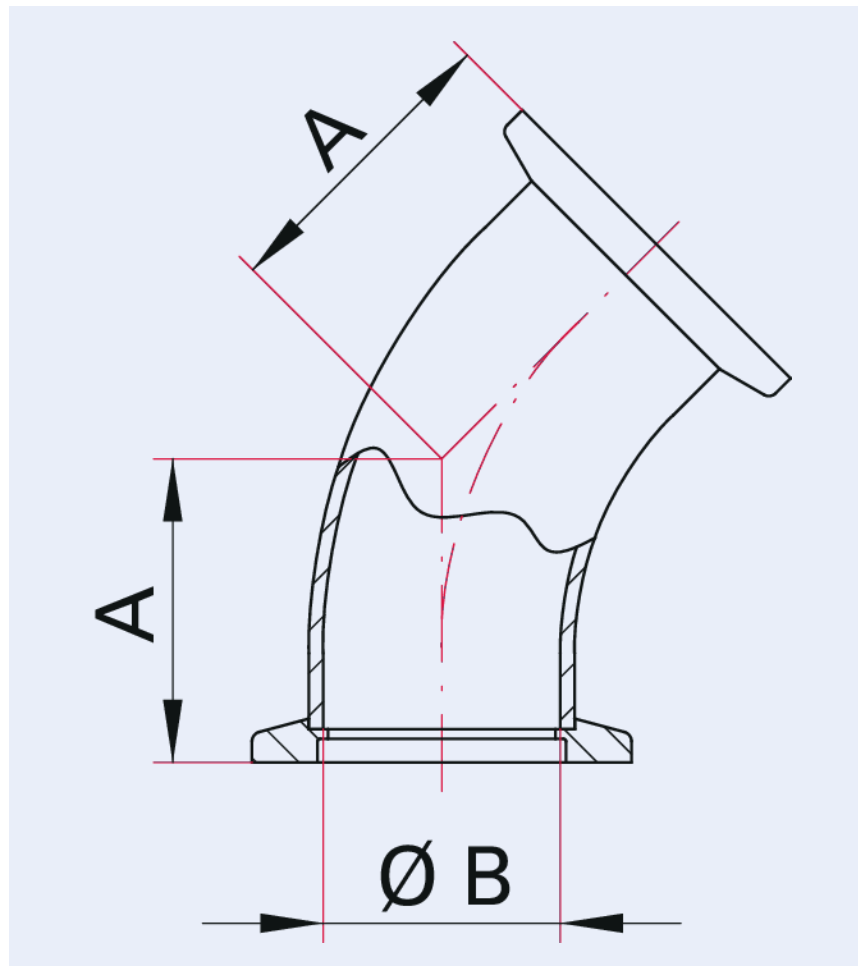

Illustration only

Elbow, 45°, stainless steel 316L/1.4404, DN 25 ISO-KF

- Various stainless steel grades available

Dimensions



A	32 mm
B	24 mm

Technical Data	Elbow, 45°, stainless steel 316L/1.4404, DN 25 ISO-KF
Materials in contact with media	Stainless steel 1.4404 (AISI 316L)
Temperature range	196 – 350 °C
Connection flange	DN 25 ISO-KF
Pressure range	1 · 10 ⁻⁸ hPa – 5 · 10 ² hPa over pressure (elastomer seal); 1 · 10 ⁻⁹ hPa – 5 · 10 ² hPa over pressure (metal seal)
Temperature range max.	350 °C 662 °F 623.15 K
Temperature range min.	196 °C 320.8 °F 77.15 K

Order number	Elbow, 45°, stainless steel 316L/1.4404, DN 25 ISO-KF
Elbow, 45°, stainless steel 316L/1.4404, DN 25 ISO-KF	170RRB025-45



Errors and/or changes excepted. - 5/14/2025

Are you looking for an optimum vacuum solution?

Talk to us:

Pfeiffer Vacuum Components & Solutions GmbH Germany

T +49 551 99963-0

info-cs@pfeiffer-vacuum.com

Or scan the barcode, to visit our web page:



<https://webportal.pfeiffer-vacuum.com/global/en/contact>

Follow Us On Social Media

#pfeiffervacuum



www.pfeiffer-vacuum.com

PFEIFFER 