

**Half nipple, rotatable,
stainless steel,
DN 63 CF**



PFEIFFER 

Half nipple, rotatable

PFEIFFER 

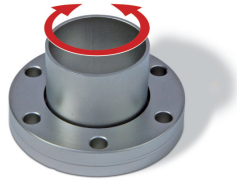
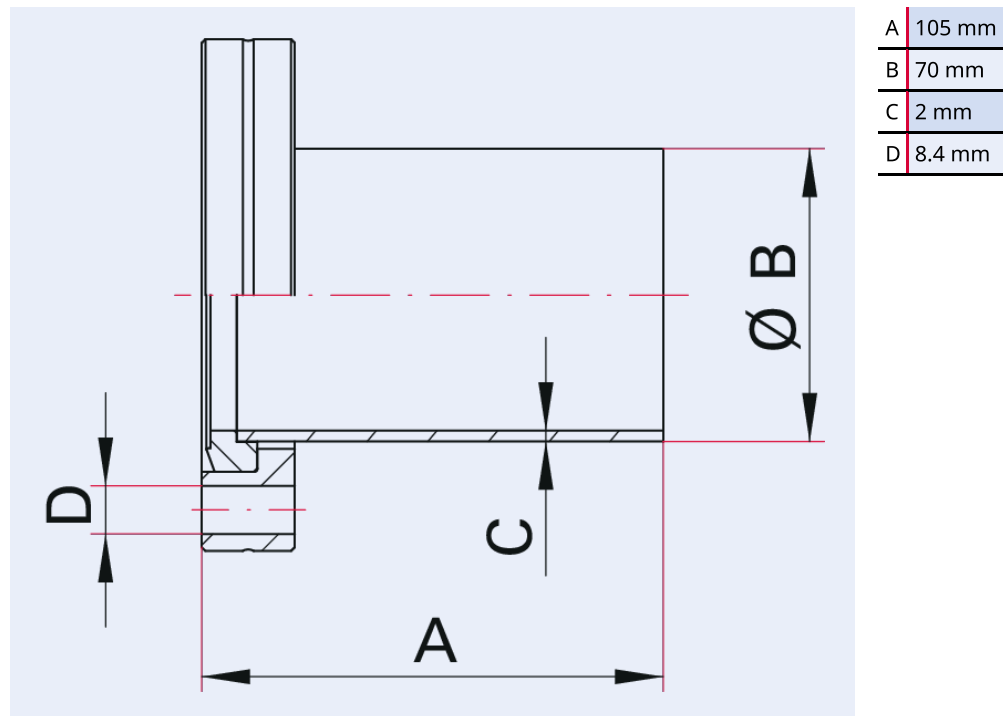

Illustration only

Half nipple, rotatable, stainless steel, DN 63 CF

- Pipe surface: glass-bead blasted (polished version on request)
- Other flange and tube materials on request
- Other pipe dimensions on request

Dimensions



Technical Data	Half nipple, rotatable, stainless steel, DN 63 CF
Pipe dimension	70 mm × 2 mm
Temperature range	196 – 300 °C
Tightness	1 · 10 ⁻¹¹ Pa m ³ /s 7.5 · 10 ⁻¹¹ Torr l/s 1 · 10 ⁻¹⁰ mbar l/s
Connection flange	DN 63 CF
Pressure range	1 · 10 ⁻¹² hPa – to ambient pressure
Material	Flange: stainless steel 304L; tube: stainless steel 304L or better
Temperature range max.	300 °C 572 °F 573.15 K
Temperature range min.	196 °C 320.8 °F 77.15 K

Order number	Half nipple, rotatable, stainless steel, DN 63 CF
Half nipple, rotatable, stainless steel, DN 63 CF	420FRD063-70-105



Errors and/or changes excepted. - 5/14/2025

Are you looking for an optimum vacuum solution?

Talk to us:

Pfeiffer Vacuum Components & Solutions GmbH Germany

T +49 551 99963-0

info-cs@pfeiffer-vacuum.com

Or scan the barcode, to visit our web page:



<https://webportal.pfeiffer-vacuum.com/global/en/contact>

Follow Us On Social Media

#pfeiffervacuum



www.pfeiffer-vacuum.com

PFEIFFER 