



**Conical reducing piece,
stainless steel
304/1.4301, DN 40-
16 ISO-KF**



PFEIFFER 

Reducing piece, conical

PFEIFFER 

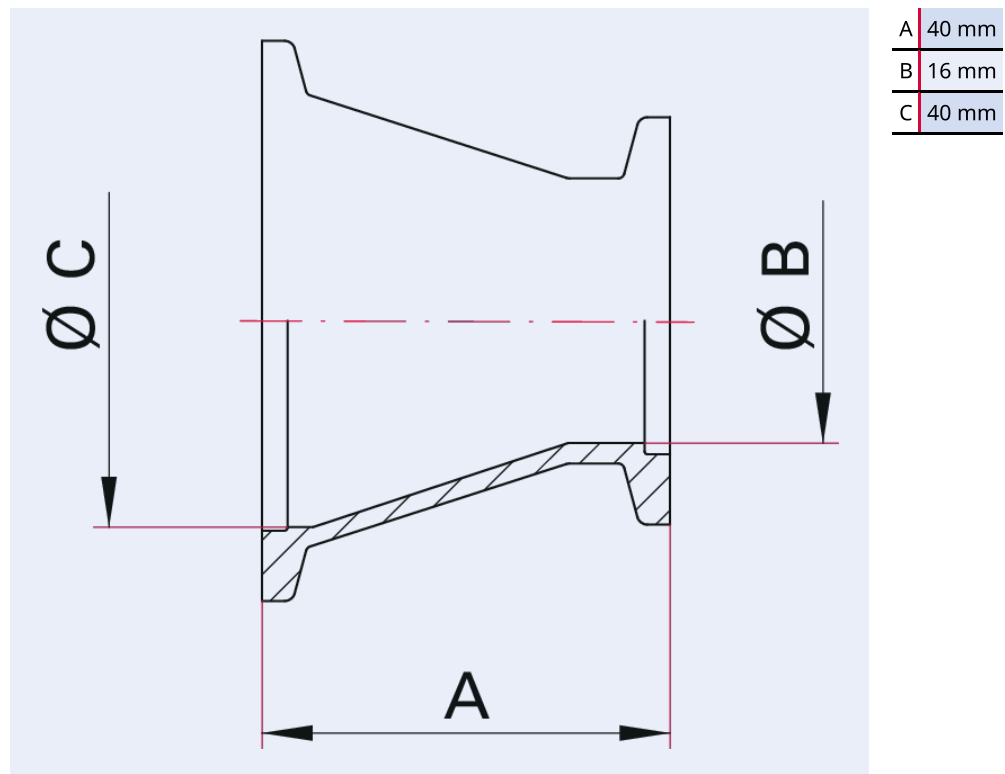

Illustration only

Conical reducing piece, stainless steel 304/1.4301, DN 40-16 ISO-KF

- Flanges according to DIN 28403 and ISO 2861

Dimensions



Technical Data	Conical reducing piece, stainless steel 304/1.4301, DN 40-16 ISO-KF
Materials in contact with media	Stainless steel 1.4301 (AISI 304)
Nominal diameter reduced	DN 16 ISO-KF
Temperature range	196 – 300 °C
Connection flange	DN 40 ISO-KF – DN 16 ISO-KF
Pressure range	1 · 10 ⁻⁸ hPa – 5 · 10 ² hPa over pressure (elastomer seal); 1 · 10 ⁻⁹ hPa – 5 · 10 ² hPa over pressure (metal seal)
Temperature range max.	300 °C 572 °F 573.15 K
Temperature range min.	196 °C 320.8 °F 77.15 K

Order number	Conical reducing piece, stainless steel 304/1.4301, DN 40-16 ISO-KF
Conical reducing piece, stainless steel 304/1.4301, DN 40-16 ISO-KF	120RRK040-016-40



Errors and/or changes excepted. - 5/14/2025

Are you looking for an optimum vacuum solution?

Talk to us:

Pfeiffer Vacuum Components & Solutions GmbH Germany

T +49 551 99963-0

info-cs@pfeiffer-vacuum.com

Or scan the barcode, to visit our web page:



<https://webportal.pfeiffer-vacuum.com/global/en/contact>

Follow Us On Social Media

#pfeiffervacuum



www.pfeiffer-vacuum.com

PFEIFFER 